

Algemene informatie

EasyAir Ventilatiebocht EPS 180 90°

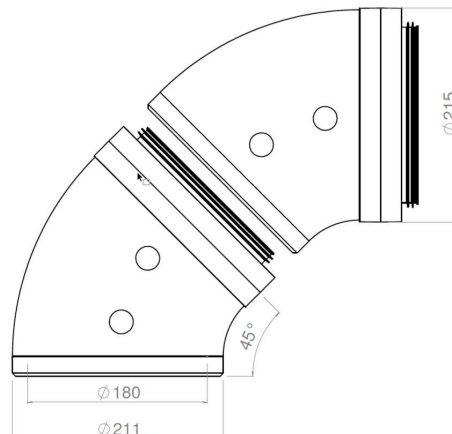

Specificaties

Artikelnummer	400480577
Producttype	Geïsoleerd kanaal
Hoofdmateriaal	EPS
Kleur	Grijs
Wanddikte luchttoevoerbuis (mm)	15,5
Netto gewicht (kg)	0,47

Afmetingen

Dn inwendig (mm)	180
Dn uitwendig (mm)	211
Afmetingen (l x b x h mm)	488 x 264 x 215

Toepassing

Beoogde toepassing	Ventilatie
Toevoer / afvoer	Toevoer/afvoer
Temperatuurbereik (°C)	-25 / +80

Technische specificaties

Maximale luchtstroom (m ³ /h)	550
ζ afvoer	0,39
ζ toevoer	0,39
Luchtdichtheidsklasse	2
λ Thermische geleidbaarheid (W/(m·K))	0,03
R-waarde (m ² K/W)	0,51
Brandklasse	E (Conform EN 13501-1)
Overige specificaties	-

Grafiek

Pressure loss

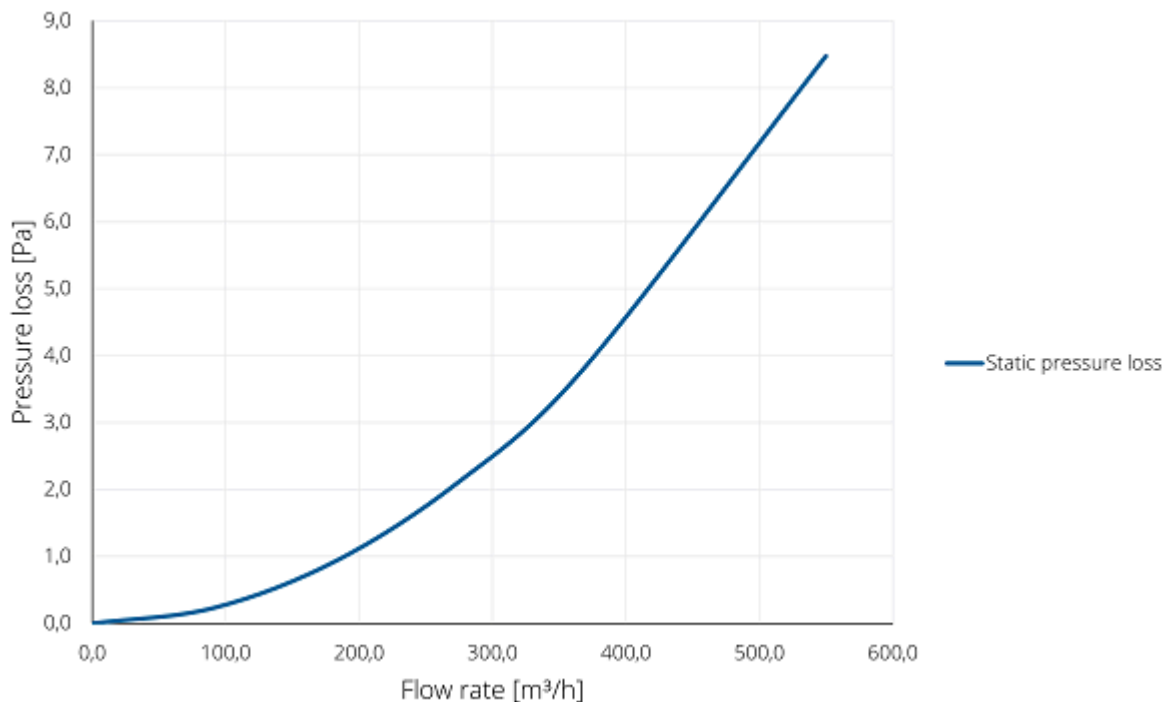

Tabel

Flow velocity pressure table

Flow rate			Static pressure loss [Pa]
[m/s]	[m³/h]	[l/s]	
0	0	0	0,0
1	92	25	0,2
2	183	51	0,9
3	275	76	2,1
4	366	102	3,8
6	550	153	8,5