

Algemene informatie

EasyAir Ventilatiebocht EPS 125 45°

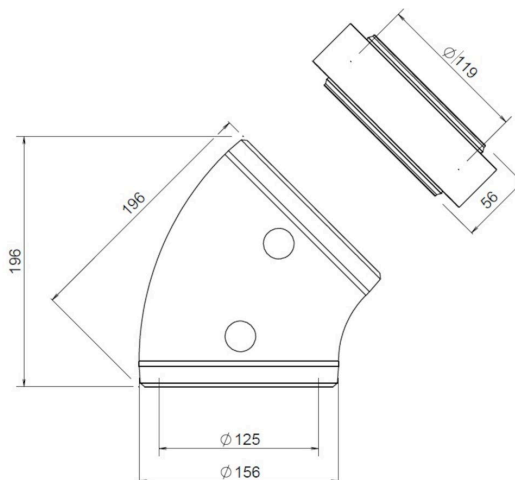

Specificaties

Artikelnummer	400480552
Producttype	Geïsoleerd kanaal
Hoofdmateriaal	EPS
Kleur	Grijs
Wanddikte luchttoevoerbuis (mm)	15,5
Netto gewicht (kg)	0,15

Afmetingen

Dn inwendig (mm)	125
Dn uitwendig (mm)	156
Afmetingen (l x b x h mm)	189 x 156 x 193

Toepassing

Beoogde toepassing	Ventilatie
Toevoer / afvoer	Toevoer/afvoer
Temperatuurbereik (°C)	-25 / +80

Technische specificaties

Maximale luchtstroom (m ³ /h)	275
ζ afvoer	0,07
ζ toevoer	0,07
Luchtdichtheidsklasse	2
λ Thermische geleidbaarheid (W/(m·K))	0,03
R-waarde (m ² K/W)	0,51
Brandklasse	E (Conform EN 13501-1)
Overige specificaties	-

Grafiek

Pressure loss

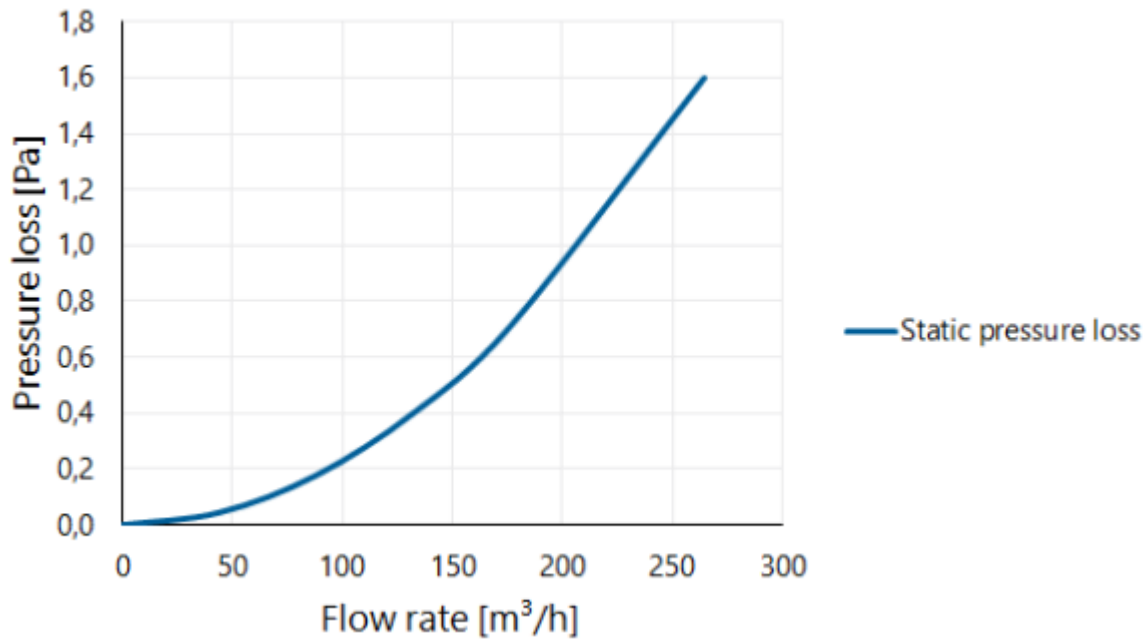

Tabel

Flow velocity pressure table

Flow rate			Static pressure loss [Pa]
[m/s]	[m³/h]	[l/s]	
0	0	0	0,0
1	44	12	0,0
2	88	25	0,2
3	133	37	0,4
4	177	49	0,7
6	265	74	1,6